

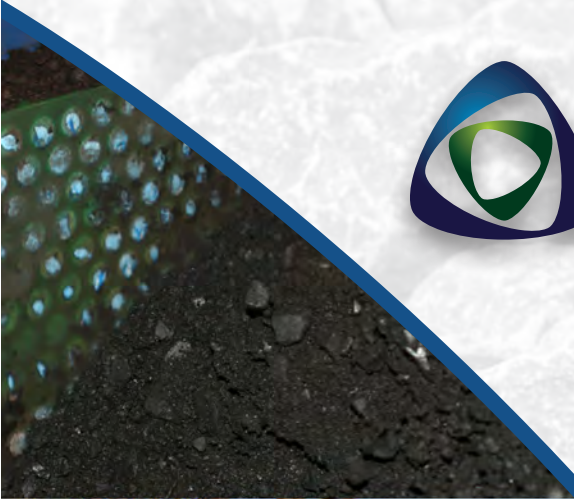

ARGONICS
ENGINEERED POLYURETHANE



**BULK MATERIAL HANDLING
PRODUCTS**



Table of Contents



Bulk Material Handling Products

- 3 Conveyor Belt Cleaning Systems
- 11 Replacement Blades
- 15 Skirting
- 23 Wear Plates
- 31 Impact Bars
- 33 Aggregate Processing Parts
- 41 Liners
- 49 Concrete Products



Conveyor Belt Cleaning Systems



Argonics is one of the country's largest producers of wear-resistant polyurethane products, providing high-performance urethane solutions at its state-of-the-art production facility. Whether you're producing concrete, manufacturing aggregate products, processing grain or mining precious metal, Argonics has built its reputation on providing cost-effective solutions for some of the most demanding applications.



BENEFITS:

- Reduces clean-up costs and creates a cleaner, safer work environment
- A variety of blade formulations are available to best fit your application, including tungsten carbide
- Design allows greater full-blade contact while easily deflecting belt splices
- Removes excessive carryback while reducing belt wear
- No rusty springs, hoses, cables or shocks to deal with
- Quick blade change out with less downtime

INDUSTRIES SERVED:

- Aggregate
- Cement
- Concrete
- Coal mining
- Coal fired power plants
- Precious metal mining
- Pulp and paper



Primary CONVEYOR BELT CLEANING SYSTEMS

MES™



The MES cleaner is a low-maintenance, high-performance cleaner with a low-profile, compact design. It uses our 6" tall polyurethane blade, and the universal mounting plates are designed to allow the cleaner to replace other OEM conveyor cleaners. The MES uses a unique internal tensioning system that allows for quick and easy tensioning.

Micro Eraser™



The Micro Eraser is your answer for portable equipment with tight clearance issues. Designed with our 6" tall polyurethane blade, it works best on belts up to 48" wide with head pulleys of 28" diameter or less. This economical but powerful system uses our patented Perma-Torque™ tensioner.

Eraser PQ™



The Eraser PQ (Pit and Quarry) system is an economical cleaner designed for performance and reliability. With a simple and effective spring tensioning unit, it uses our 6" tall polyurethane blade and requires little to no maintenance.

Eraser RPQ™



The Eraser RPQ system uses the same simple and effective spring tensioning unit as the Eraser PQ, with a 7" tall polyurethane blade, giving you more wear life and allowing for installation on systems with a larger diameter head pulley.

Primary CONVEYOR BELT CLEANING SYSTEMS

Eraser™



The Eraser system is our standard industrial workhorse. This rugged yet versatile cleaner is built around our exclusive patented Safe Torque™ tensioning system. It is equipped with a 7.25" tall polyurethane blade, and can handle most of your demanding applications with ease.

S3Max™



The S3Max is an intermediate system between the Eraser and the Super Eraser that features a 10" tall polyurethane blade. It is ideally suited for more aggressive applications where a larger blade is required, or those systems with a larger head pulley.

Super Eraser™



The Super Eraser is a Mine Duty cleaner. It has a .25" thick, 3.5" x 3.5" box steel main-frame and a massive 12" polyurethane blade. It will handle anything you throw at it. If you're dealing with high speed, high tonnage belts, the Super Eraser was built specifically for you.

Eraser MDP™



The Eraser MDP is the Super Eraser system with a one-piece 12" polyurethane blade with a patent-pending insert engineered for strength. Meant for use in the toughest, mine duty applications, the MDP is extremely rugged, durable and long-lasting.

Primary CONVEYOR BELT CLEANING SYSTEMS

Eraser HD™



The Eraser HD is designed to withstand heavy vibration. This system has a reinforced mainframe and a heavy-duty channel attachment design. It utilizes a series of 6" wide x 7" tall polyurethane blade segments that conform to crowned head pulleys.

Super Eraser HD™



The Super Eraser HD is a channel mount version of the Super Eraser. It matches Mine Duty design with segmented blade technology. If you like big equipment, this is the one. Even the harshest environments don't stand a chance against the Super Eraser HD. Available in pin style or with Safe Torque.

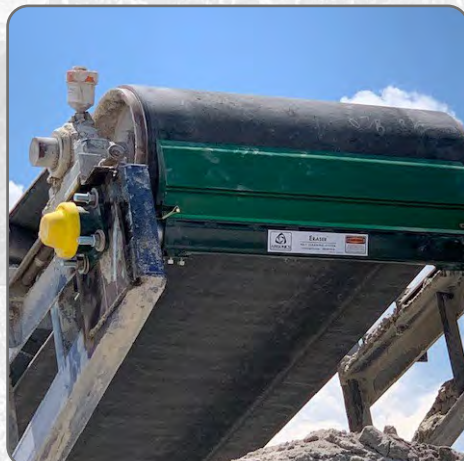

Secondary CONVEYOR BELT CLEANING SYSTEMS

XTC™



The XTC is one powerful reversing conveyor cleaner. The system can handle wet, dry, sticky or slimy conditions. The unique Web-Torque tensioner has enough give for mechanical splices and the flow-over blade design reduces material build up.

XTC™ Tungsten

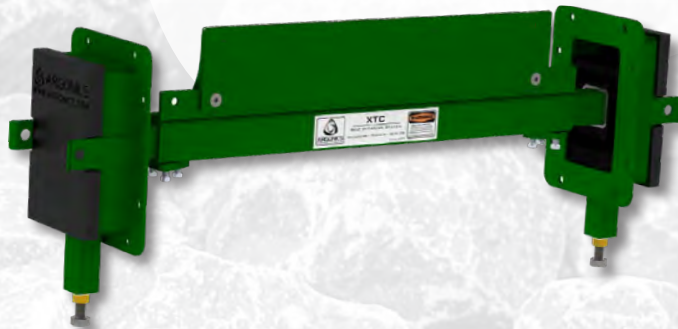

The XTC with tungsten is ideal for applications with belt speeds up to 1000 fpm. The tungsten system uses the same mainframe and unique Web-Torque tensioner as the urethane system, which has proven effective in wet, dry, sticky or slimy conditions. Tool steel- and stainless steel-tipped blades are also available.

Chevron Belt Cleaner

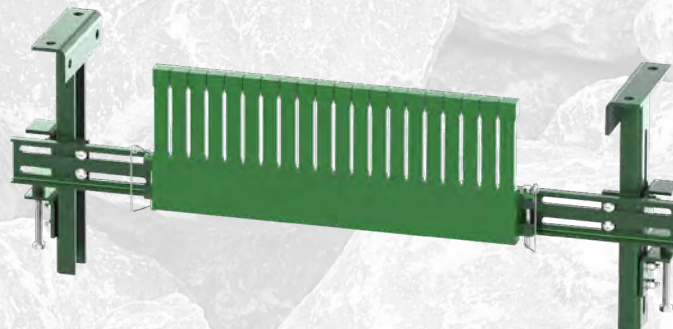

The Chevron Belt Cleaner is designed to effectively remove carryback from challenging chevron, cleated, or raised rib conveyor belts. Its flexible polyurethane fingers ensure efficient cleaning without causing any damage to the belt. The powder-coated mounting brackets offer two attachment options to suit your specific operational needs.

Secondary CONVEYOR BELT CLEANING SYSTEMS

Eraser DS™



The Eraser DS is an economical version of our XTC cleaner, with a .19" thick, 2"x 2" powder-coated tube stock steel mainframe for strength and durability. The DS uses the same polyurethane blade as the XTC.

Eraser DS™ Tungsten

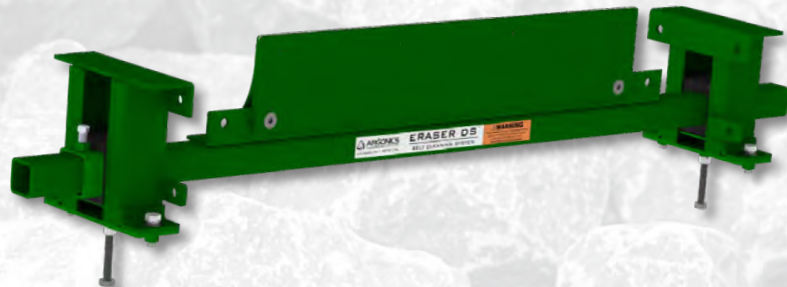

The Eraser DS tungsten system is urethane-free for use with high-temperature materials. It uses the same .19" thick, 2"x 2" powder-coated tube stock steel mainframe as the DS system. It also utilizes the same tungsten carbide blades as the XTC.

Brush Cleaner



The Brush Cleaner is a completely contained system, which utilizes a Van der Graaf drum motor. This motor is an enclosed unit with all motorized parts inside the roller, making it the choice for the most challenging environments. The compact, low-profile design operates at 96% efficiency and is virtually maintenance-free. It is ideal for use on chevron or cleated belts.

Secondary CONVEYOR BELT CLEANING SYSTEMS

Super-G™



The Super-G's unique "pass-through" mainframe design allows material to freely fall through it, keeping your systems online with little to no maintenance. This system is based on the same heavy-duty mainframe and Perma-Torque tensioner as our Eraser system.

Super-G™ Tungsten



The Super-G with tungsten features a completely unique, redesigned blade. It uses the same mainframe and Perma-Torque tensioner as the urethane Super-G. The urethane cartridge holds the 6" tungsten blade tips, which allows the blades to flex with and maintain contact and pressure against the belt.

Super-G™ XL



The tungsten Super-G XL is a longer version of the tungsten Super-G, available in lengths of 72", 84", and 96". The Super-G XL is built on a .25" thick, 3.5" box steel mainframe, similar to the Super Eraser. Pins in the center allow it to hold two of our tungsten-tipped urethane blades, which flex to maintain pressure against the belt.

Diagonal Plow

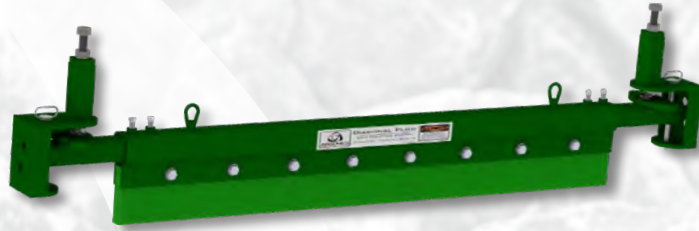

The V-Max X-Plow may seem simple, but don't be fooled, it works!

Thanks to the adjustable down pressure system, this single-minded plow will reduce your down time and increase your bottom line.

Aluminum Diagonal Plow

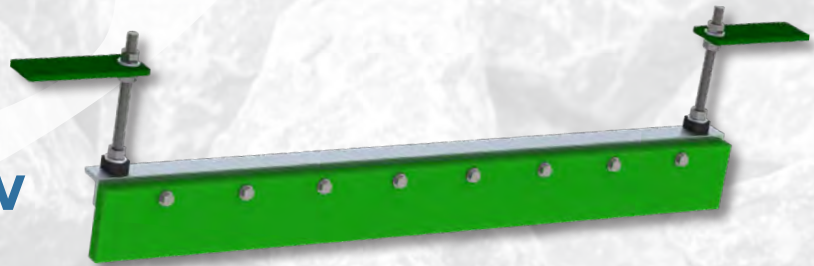

The Aluminum X-Plow offers complete cleaning at an economical price. Utilizing the same blade as the V-Max X-Plow with a lightweight aluminum mainframe, this system is best suited to quarry or other like environments.

V-Max V-Plow™

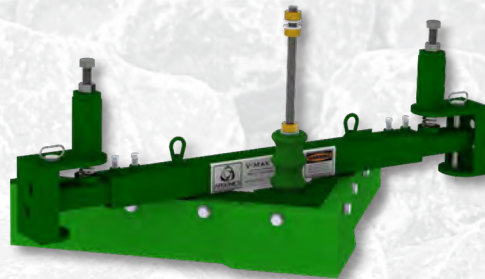

The V-Max V-Plow has seen duty in some of the world's largest quarries and has protected them from major damage and costly repairs. Dirt and rocks can get caught in between the belt and pulleys, ripping holes and creating hours of costly downtime. The V-Max delivers adjustable down force, so nothing will get through.

Aluminum V-Plow™

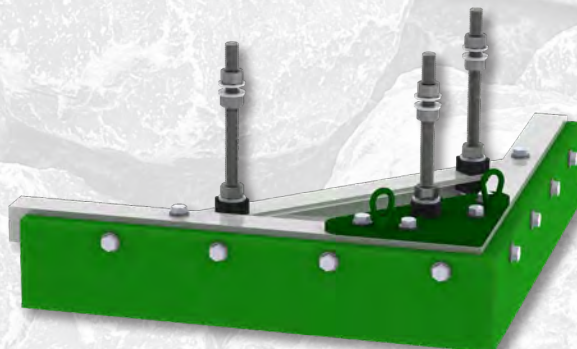

The Aluminum V-Plow is an economical solution for budget-conscious quarries that want the protection that a v-plow offers. The Aluminum V-Plow glides on the belt's surface, effectively removing the dirt and rocks while keeping an eye on your budget.

Replacement Blades FOR MOST OEM SYSTEMS



The Argonics primary and secondary replacement blades are specifically engineered to eliminate carryback by removing debris from the belt's surface. They are field-tested and proven to withstand the most severe conveying environments around the world, outlasting any other polyurethane blade by a 2-to-1 margin.

Our blades use our proven Kryptane® polyurethane formula. They directly retrofit OEM systems with no adaptation necessary.

RETROFIT BLADES AVAILABLE:

ARCH Environmental Equipment, Inc.

Gordon Saber® Mini Blade (Raptor MGS™)
Gordon Saber® Primary Blade (Raptor GS™)
Gordon "SCM" Channel Mount Blade (Raptor GSC™)
Gordon "SCM" Channel Mount Blade (Raptor GSC2™)

ASGCO® Manufacturing, Inc.

Mini-Skalper (Raptor AGM™)
Skalper I® Blade (Raptor AGC™)
Skalper II®
Skalper IV® Blade (Raptor AG2™)
Super-Skalper® Blade (Raptor AS2™)

American Eagle

E4 Series Uni-Blade™ (Raptor BT™)
E1/E5 Series Uni-Blade™ (Raptor MPV™)

Benetech®

AdvantEdge™ Primary Cleaner (Raptor BT™)

Flexco

Rockline™ Primary Belt Cleaner (Raptor RL™)
Mineline™ Primary Belt Cleaner (Raptor ML™)
MegaShear™ Primary Blade (Raptor FMS™)

Richwood Industries Inc.

Combi-T® 1C and 1C-ITC Blade (Edge™)

Superior Industries

Exterra® Primary Blade (Raptor MPV™)

Martin® Engineering

QC1™ Low Profile Single Notch Blade (Raptor MLP™)
QC1™ Low Profile Double Notch Blade (Raptor MDL™)
QC1™ Standard Profile Single Notch Blade (Raptor MSP™)
QC1™ Standard Profile Double Notch Blade (Raptor MDS™)
QC1™ Heavy Duty Profile Blade (Raptor MHP™)
QC1+™ HD Profile Blade - Clamp Style (Raptor MQA™)
QC1+™ PV Profile Blade - Clamp Style (Raptor MQB™)
QC1+™ XHD Profile Blade - Clamp Style (Raptor MQC™)
QC1™ Extra Heavy Duty Profile Blade (Raptor MXA™)
QC1™ Extra Heavy Duty Profile Blade (Raptor MXB™)
Pit Viper™ Blade (Raptor MPV™)
Durt Tracker® Blade (Raptor MHD™)
Durt Tracker® Blade (Raptor DT2™)
XHD Durt Tracker® (Raptor DX™)
Durt Hawg® Primary Blade (Raptor MDH™)
Durt Hawg® Primary Blade (Raptor DH2™)
Durt Hawg® Secondary Blade (AccuFlo PigHead™)

Saber® is a registered trademark of ARCH Environmental Equipment Inc., Paducah, KY. · ASGCO® and Skalper® are registered trademarks of ASGCO Manufacturing, Inc., Allentown, PA. · Uni-Blade™ is a trademark of American Eagle Manufacturing LLC, New Bern, NC. · Benetech® is a registered trademark of Benetech, Inc., Aurora, IL. AdvantEdge™ is a trademark of Benetech, Inc., Aurora, IL. · Rockline™, Mineline, and MegaShear™ are trademarks of Flexco, Downers Grove, IL. · Metso® is a registered trademark of Metso Corporation, Helsinki, Finland. · Combi-T® is a registered trademark of Richwood Industries, Inc., Huntington, WV. · Exterra® is a registered trademark of Superior Industries, Inc., Morris, MN. · Martin®, Durt Tracker®, and Durt Hawg® are registered trademarks of Martin Engineering, Neponset, IL. Pit Viper™, QC1™, and QC2™ are trademarks of Martin Engineering, Neponset, IL.

Blade Durometer SELECTION GUIDE

Formula/Durometer Color	Application	Material	Temperature
ETHER 62 (N62)	Normally used for extremely wet applications, sands & fines	Lots of liquid on belt, sand or slurry	-40°F to 180°F
ETHER 80 (R80)	Good for wet applications with any pH level	Fine particles including sand, grain, ³ / ₈ " minus washed materials	-40°F to 225°F
ESTER 83 (G83)	Our standard, high abrasion-resistant all-purpose cleaning blade	Most sand and gravel materials, coal, ores	-40°F to 225°F
ETHER 90 (U90)	Good for dry applications with any pH level	1/2" washed / finished product. Wood chips, cement, limestone, grain, sugar, clay or other sticky material	-20°F to 225°F
ESTER 93 (B93)	Our high temperature cleaning blade	Extremely coarse aggregate, asphalt, recycled materials, glass, higher temp, sticky applications	-20°F to 250°F Up to 300°F intermittent
FRAS (RU83)	Flame-retardant, anti-static, cleaning blade. Argonics is one of the only blade manufacturers in the US to offer this formula	Coal mining and coal-fired power plants	-40°F to 225°F
FLAME RETARDANT (FOxx) - CAN BE ANY DUROMETER	MSHA approved, FrontLine® flame-resistant cleaning blade	Flame retardant urethane (can be any durometer or formula)	Temperature varies depending on the durometer
CERAMIC (CALL FOR AVAILABILITY)	Good for very cold, winter applications or frozen materials		Temp. varies depending on the durometer, typically G83



FEATURES:

- Safer operation
- Easier to tension
- Corrosion resistant
- One hand adjustment
- No kickback or pins
- Completely sealed

SAFE TORQUE RATCHET SYSTEM

The Safe Torque ratchet tensioner is available on most Argonics conveyor belt cleaning systems. Our Safe Torque tensioner is a unique solid urethane ratchet style adjustment device, specifically designed to work in conjunction with our patented Perma-Torque™ tensioning system. The Perma-Torque tensioner applies constant blade pressure across the full length of the head pulley.

The Safe Torque ratchet actuating system offers the unique ability to tension a conveyor belt cleaning system with only one hand, and is extremely useful in confined areas. The supplied dust cap seals the system from fine particle impaction, common to so many tensioners on the market today. You'll benefit from the ease of use and the inherent safety that our Safe Torque ratchet tensioner offers.

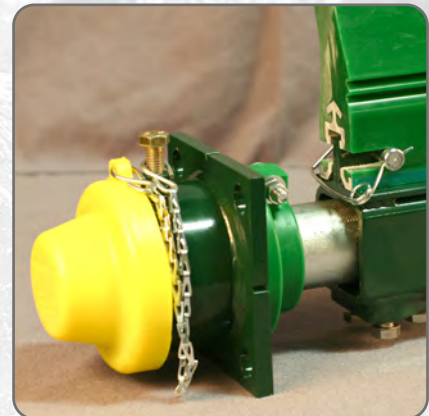

PRIMARY CLEANER SELECTION GUIDE

System Name	Max Belt Speed in FPM	Min Pulley Diameter	Max Pulley Diameter	Max Belt Width	Tensioner
Eraser™ MDP	1200	24"	60"	96"	Safe Torque™
Super Eraser™	1000	24"	60"	70"	Safe Torque™
S3 Max™	900	24"	48"	96"	Safe Torque™
Super Eraser HD™	1000	24"	60"	120"	Safe Torque™
Eraser HD™	750	16"	48"	96"	Safe Torque™
Eraser™	750	16"	32"	96"	Safe Torque™
Eraser™ RPQ	450	8"	24"	60"	Spring
Eraser™ PQ	450	8"	20"	60"	Spring
Micro Eraser™	500	8"	20"	72"	Pin Style
MES™	500	8"	20"	54"	Quick Torque™

SECONDARY CLEANER SELECTION GUIDE

System Name	Max Belt Speed in FPM	Max Belt Width	Blade
XTC™	750	72"	Polyurethane
XTC™	1000	96"	Tungsten
Eraser DS™	600	72"	Polyurethane
Eraser DS™	900	72"	Tungsten
Super-G™	750	72"	Polyurethane
Super-G™	900	60"	Tungsten
Super-G XL™	900	96"	Tungsten
Chevron Belt Cleaner	500	72"	Polyurethane
Brush Cleaner	Varies	72"	Nylon bristles (others available)

PLOW CLEANER SELECTION GUIDE

System Name	Max Belt Speed in FPM	Max Belt Width	Mainframe
V-Max™ V-Plow	1000	96"	Steel
Aluminum V-Plow	750	72"	Aluminum
V-Max™ X-Plow	1000	96"	Steel
Aluminum X-Plow	750	72"	Aluminum



ARGONICS
ENGINEERED POLYURETHANE

520 9th Street • Gwinn, MI 49841
906.226.9747 f: 906.226.9779
www.argonics.com



Dust Skirting and Material Containment



Argonics is one of the country's largest producers of wear-resistant polyurethane products, providing high-performance urethane solutions at its state-of-the-art production facility. Whether you're producing concrete, manufacturing aggregate products, processing grain or mining precious metal, Argonics has built its reputation on providing cost-effective solutions for some of the most demanding applications.

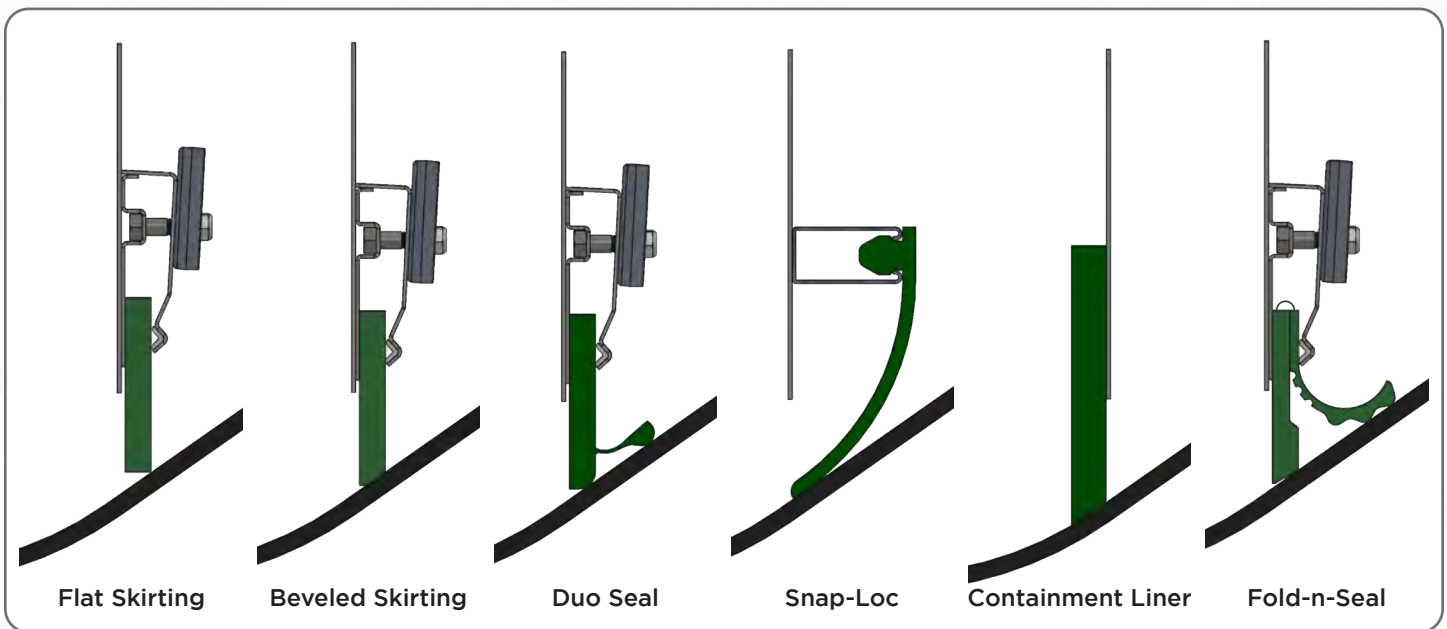

BENEFITS:

- 8-10 times the wear life over rubber
- 60 percent lower coefficient friction compared to rubber, which reduces drag on the conveyor motor
- Will not groove your conveyor belt
- Light-weight
- Load-bearing
- Can be formulated to work in wet or dry conditions

INDUSTRIES SERVED:

- Aggregate
- Cement
- Concrete
- Coal mining
- Coal fired power plants
- Precious metal mining
- Pulp and paper



Conveyor Belt Skirting

Standard Skirting

- Fits into any other manufacturers' existing skirt clamping systems on the market today
- Available in a variety of widths and thicknesses in lengths up to 50 feet
- Can be ordered with 35-degree beveled edges* or a straight edge

*The beveled edge provides an even greater advantage because it already matches the troughing angle of your belt, eliminating the "break-in" adjustment.

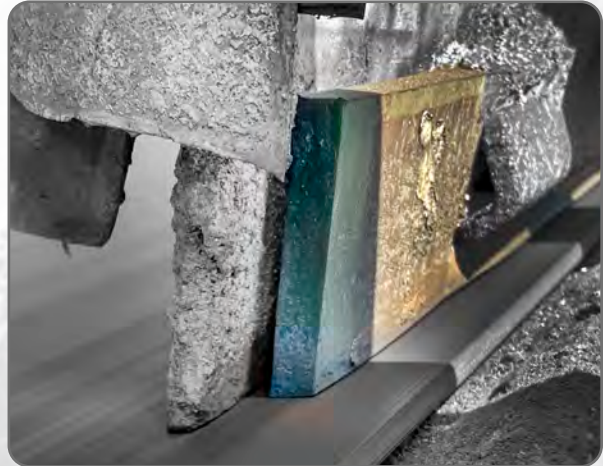

Standard Skirting Sizes:

Thickness	1/4", 3/8", 1/2", 5/8", 3/4", 1"
Seal Height	4", 5", 6", 8", 9", 10", 12"
Bevel	0°, 35°
Length	50', 50'+ (with surcharge)



Flat Skirting



Beveled Skirting



Duo Seal™

- Material and dust containment in one solution
- Flexible secondary seal conforms to the belt to keep dust and particulate material under control
- Works with most existing skirt board clamping systems on the market
- Available in a variety of widths and thicknesses, in lengths up to 50 feet
- Rounded primary seal will work with any trough angle

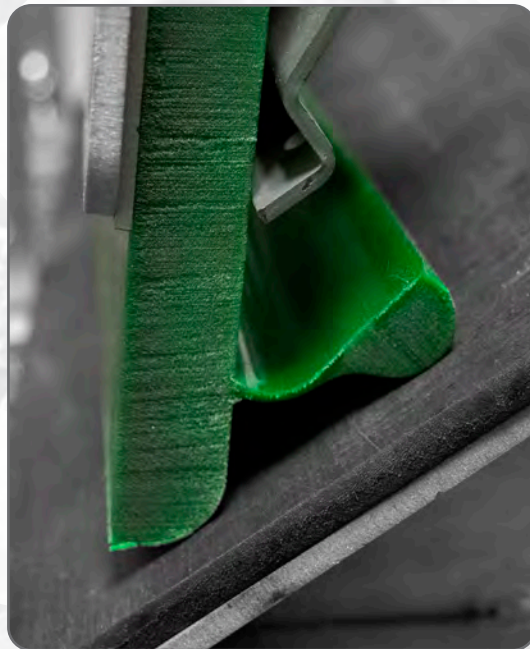

Duo Seal Sizes:

Thickness	1/2", 3/4"
Seal Height	4", 5", 6", 8"
Length	50', 50'+ (with surcharge)

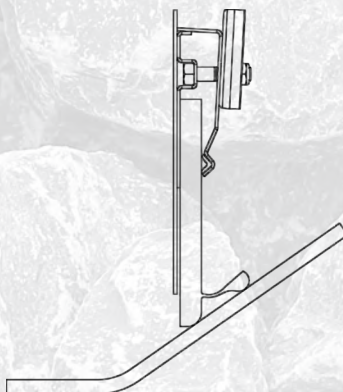

Load Zone Containment Liner

- Excellent for containing material at the transfer points on your belt line
- Extra-rugged, reinforced design with 1/4" steel
- Extremely effective in reducing spillage
- Available with flat edge or 20-degree beveled edge
- Plain liners come in 60" and 96" lengths; varying heights and thicknesses available
- 1" thick ceramic liners contain ceramic hextiles, while the 2" contains ceramic cubes
- Ceramic liners available with flat, 20° or 35° beveled edge, in lengths of 48 inches or 60 inches

Containment liners come with Snap-Tite polyurethane plugs that cover the mounting slots and prevent material build-up.



Containment Liner Sizes:

Thickness	1", 2"
Height	6", 8", 10", 12"
Length	24", 36", 48", 60", 72", 96"
Bevel	0, 20°, 35°, 45°
Bevel Type	Single, double

Ceramic Containment Liner Sizes:

Thickness	1", 2"
Height	8", 10", 12"
Length	48", 60"
Bevel	0, 20°, 35°
Ceramics	Hextiles, cubes

Snap-Loc™ Dust Seal

- The gold standard for dust containment skirting
- Snaps into standard unistrut railing that can be bolted or welded into place
- Engineered to create a perfect seal that follows the contours and low spots of the belt between trough rollers
- No additional adjustments needed for the life of the seal
- Available with cavity for use on high-speed belts



Snap-Loc Sizes:

Seal Height	5", 6", 9", 14"
Length	50'
Cavity	With, without

Combination Snap-Loc System

- Combination of Snap-Loc and Containment Liner work together to provide the ultimate dust control product
- Fits most conveyor systems on the market
- Excellent abrasion and high-temperature resistance
- Can be used with all belt widths and troughing angles

*The combination of Snap-Loc and Containment Liner is not sold together as a single unit; however, field testing has proven that these two products work exceptionally well together to provide solutions to dust problems.



Conveyor Belt Skirting

Fold-n-Seal™

- Quality, multi-sealing conveyor skirting solution
- Material and dust containment in one unique solution
- Primary seal keeps material on the belt while secondary seal keeps dust and particulate material under control

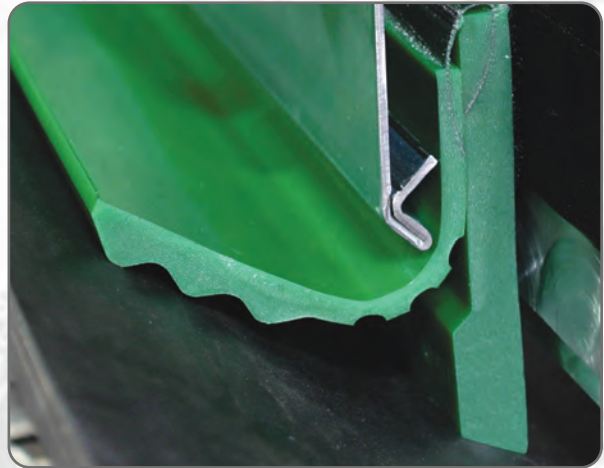

Fold-n-Seal Sizes:

Seal Height	5"
Thickness	3/4"
Length	50'

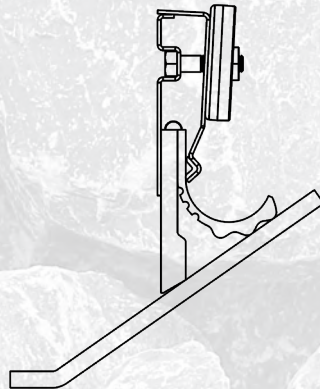

Wedge-Loc™

- Easy to install and adjust
- Stitch, weld, or bolt into place, install skirting, drop to belt, then knock wedges to lock down
- Frame made from 12-gauge, galvanized steel; clamping utilizes a stainless steel-to-brass thread contact, coupled with cast aluminum wedge for continuous operation in corrosive and abusive environments
- Accommodates skirting up to 1" thick
- Argonics recommends 3 clamps per 4' section

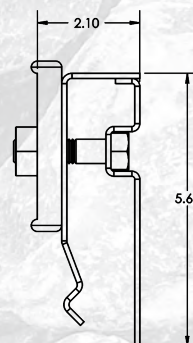
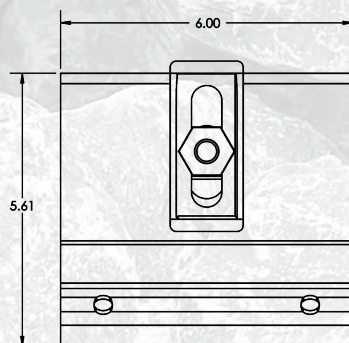
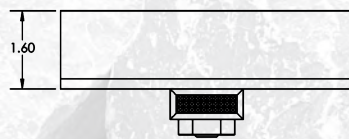
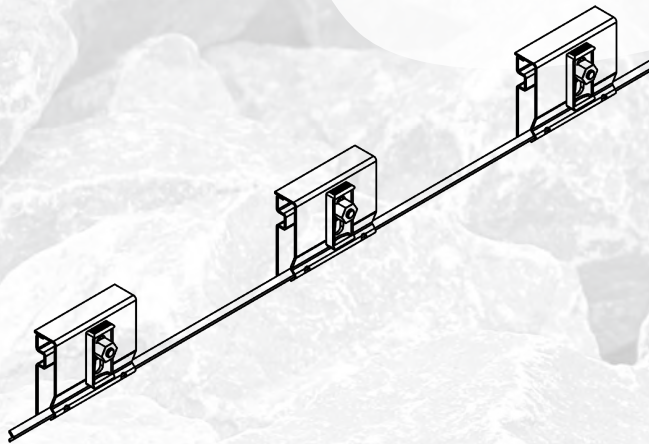

69

The most common skirting durometer choice

83

Typically used for belt speeds in excess of 600 FPM

93

Used on belts with elevated temperatures, up to 250° F constant temperature

FL

Front Line®, our flame retardant formulation, is MSHA approved and can be added to any durometer

FRAS

Flame Retardant Anti-Static (FRAS) combines our Front Line® flame retardant with a proprietary anti-static additive, making it perfect for use in underground mining and coal fired power plants



ARGONICS
ENGINEERED POLYURETHANE

520 9th Street • Gwinn, MI 49841
906.226.9747 f: 906.226.9779
www.argonics.com



Wear Plates

MODULAR LINING SYSTEM



Our wear plates can be arranged into any wear pattern that is needed. Their unique, simple installation methods allow you to replace only what's needed, instead of replacing the entire liner set. They are available in many sizes, with and without ceramic, and in a variety of installation methods, including magnetic.

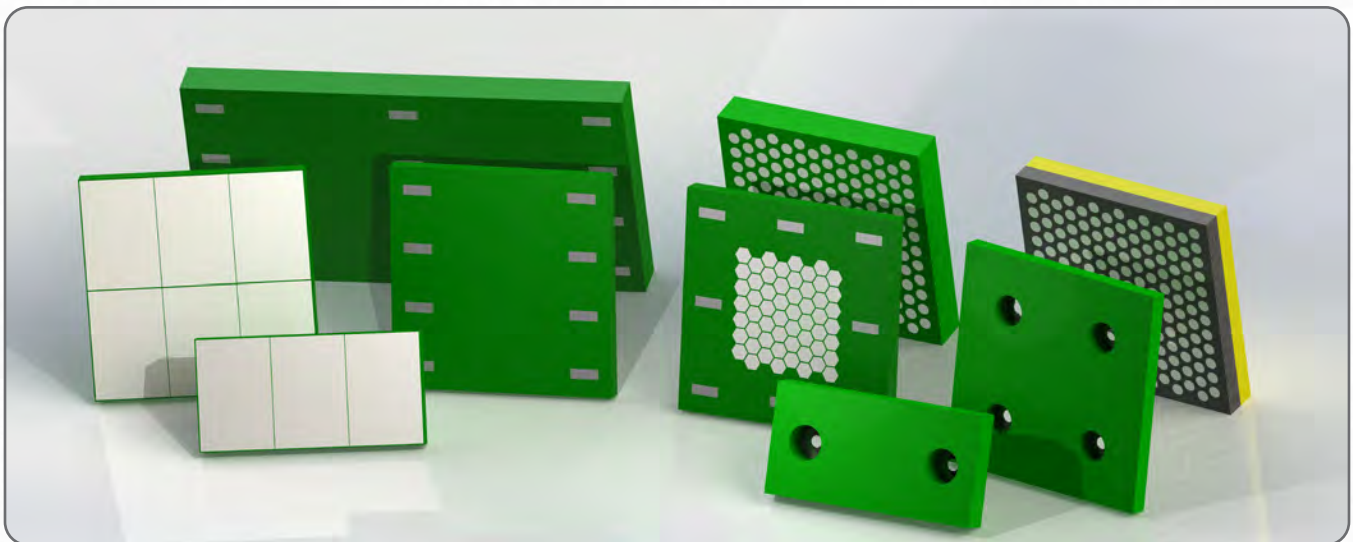

PERFECT FOR THESE APPLICATIONS:

- Conveyor transfer points
- Screen feed liners
- Chutes with high wear
- Charge chutes
- Screen discharge liners

WEAR PLATE PRODUCTS:

- Redi-Liner with and without ceramic
- Dual durometer Redi-Liner with ceramic
- Modular wear plates
- Magnetic wear plates
- Ceramic tile magnetic wear plates
- Magnetic ceramic patch

Redi-Liner Bolt-in Wear Plates

- Bolt-in 6"x12" and 12"x12" panels can be arranged into any wear pattern that is needed
- Single-bolt install method for easy installation
- Unique, simple installation method allows you to replace only what's needed, instead of replacing the entire liner
- Requires no maintenance, will outlast most any other wear product available today
- Provides protection for your toughest hot spots in loading areas, bin hoppers and drop zones
- Available in solid polyurethane or with ceramics

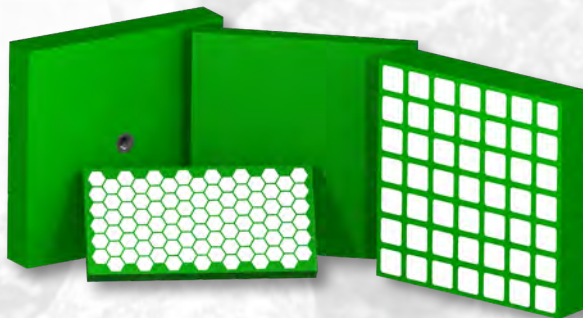

Redi-Liner Sizes:

Size	6"x12", 12"x12"	6"x12", 12"x12"	6"x12", 12"x12"	6"x12", 12"x12"
Thickness	1"	1½"	2"	2½"
Ceramic options	¼" hextiles	½" hextiles	½" hextiles or ⅜" cylinders	¼" cylinders or ½" cubes



Redi-Liner Dual Durometer Ceramic Wear Plates

The Dual Durometer Ceramic Redi-Liner bolt-in 12"x12" wear plates can be arranged into any wear pattern that is needed. Available in a 93/69 durometer combination, the plates fuse the abrasion-resistant qualities of ceramic and harder urethane with the impact absorption of the softer urethane in the back.

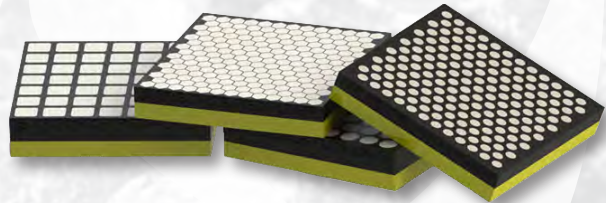

- The top, outer facing layer is ceramics embedded in a hard durometer, which is very abrasion-resistant
- Bottom layer, which faces the mounting structure, is a softer, impact-absorbing durometer
- Single-bolt installation method
- The dual durometer ceramic wear plates exhibited 18% less rebound when compared to our single durometer ceramic plates

Redi-Liner Dual Duro Ceramic Sizes:

Size	12"x12"	12"x12"	12"x12"
Thickness	2"	2 1/2"	4"
Ceramics	1/2" hextiles or 13/16" cylinders	1/4" cylinders or 1 1/2" cubes	1 1/2" cubes

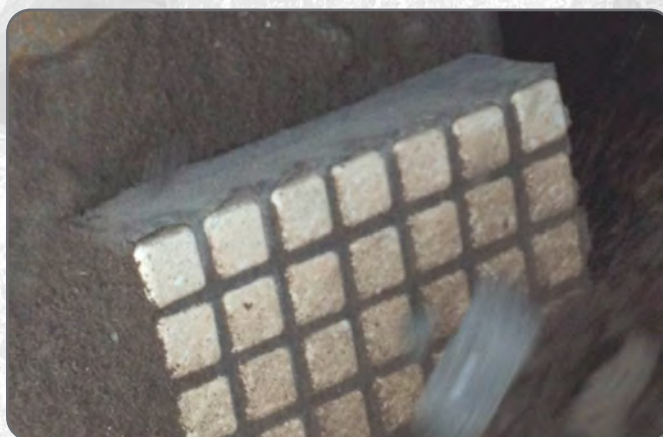

Modular Wear Plates

Modular wear plates help eliminate material adhesion and dampen noise levels significantly. These polyurethane wear plates have been proven to be cost-effective over steel liners by as much as 5-to-1.

- Panels can be placed together to easily address wear areas of any size
- Kryptane® polyurethane outlasts rubber and steel AR plate
- High level of abrasion resistance
- Low coefficient of friction
- High-performance urethane extends plate life
- Available in a variety of standard sizes, as well as weldable and boltable options
- Custom sizes available

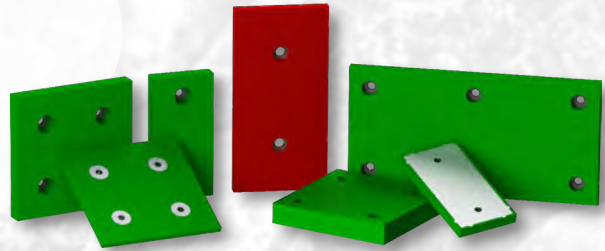

Modular Wear Plates Sizes:

Size	6"x12", 9"x18", 12"x12", 12"x24"
Thickness	1/2", 1", 1 1/2", 2", 2 1/2"



Magnetic Wear Plates

Our magnetic modular wear plates can be quickly and easily installed into any pattern to help reduce wear in critical areas of your operation.

- Strong rare earth magnets hold the wear plates in place. No welding, gluing or bolting necessary!
- Wear plates can be placed together to easily address wear areas of any size
- Kryptane® polyurethane outlasts rubber and steel AR plate
- Available in a wide variety of formulations
- Custom sizes available



Magnetic Panels Sizes:

Size	6"x6", 6"x12", 12"x12", 12"x24", 18"x18"
Thickness	1", 1½", 2", 2½"



Ceramic Tile Magnetic Wear Plates

Ceramic tile magnetic wear plates are the newest addition to our modular lining product offerings. 4"x6" ceramic tiles offer a nearly uninterrupted ceramic surface, providing extreme wear protection.

Strong magnets hold the wear plates firmly in place, even on vibrating applications. Our 1" thick plates come in 6"x12" and 12"x12" sizes, allowing you to custom fit to your specific wear pattern needs.

- Strong rare earth magnets hold the wear plates in place. No welding, gluing or bolting necessary!
- Ceramic tiles provide nearly uninterrupted surface for extreme wear protection

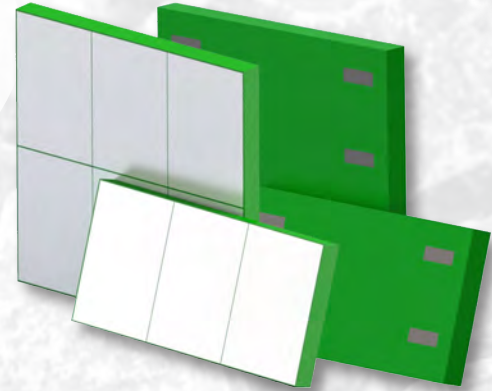

Ceramic Tile Magnetic Wear Plate Sizes:

Size	6"x12", 12"x12"
Thickness	1"
Ceramics	1/2"x4"x6" ceramic tiles



Magnetic Ceramic Patches

- Strong rare earth magnets hold the patches in place. No welding, gluing or bolting necessary!
- Our 1/2" thick patches are perfect for covering holes in contoured walls or chutes
- The hextile ceramics face toward the worn spot to offer extra protection
- Patch is intended to provide a temporary fix until repairs can be scheduled
- Stays firmly in place even on vibrating applications

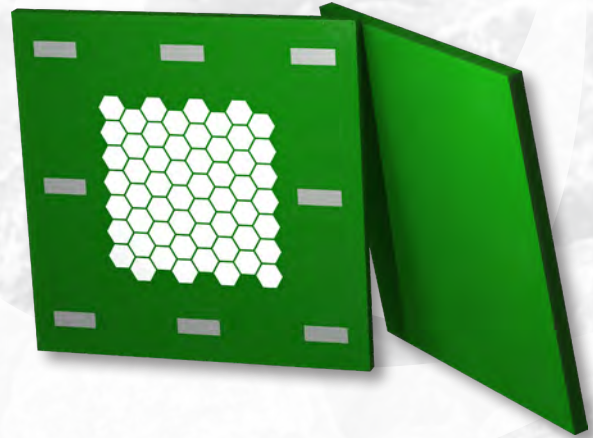

Magnetic Ceramic Patch Sizes:

Size	12"x12"	12"x12"
Thickness	1/2"	1"
Ceramics	1/4" hextiles	1/2" hextiles

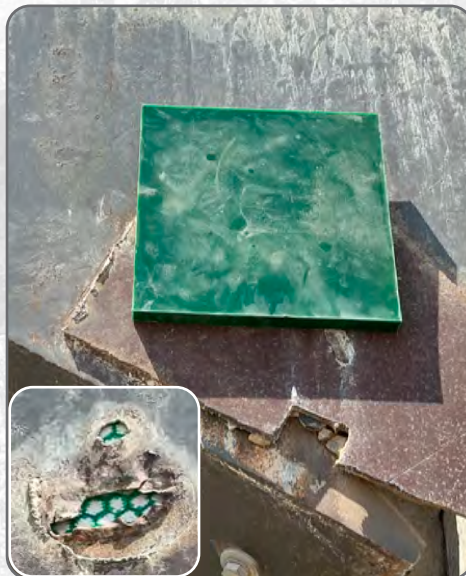

LINER THICKNESS AND CERAMICS GUIDE

Liner Overall Thickness	Ceramic Type	Max. Nominal Aggregate Size (in.)	Max. Impact Distance* (ft.)
0.5"	Solid urethane	1"	4'
1"	Solid urethane	2"	6'
1.5"	Solid urethane	3"	8'
2"	Solid urethane	4"	10'
1"	KX 1/4" hextile	1"	1'
1"-2"	KT 1/2" hextile or tile	2"	2'
2"	KC 13/16" cylinders	4"	6'
2.5"	KS 1.25" cylinders	6"	8'
2.5"	KH 1.5"x1.5"x1.5" cubes	8"	10'
4"	KH 1.5"x1.5"x1.5" cubes (dual duro)	12"	14'

This chart is not comprehensive. Following the above guidelines allows for optimal life of the liner. Wear life is also impacted by the angle of impact. For more information tailored to your specific application, contact Argonics.

*Max. impact distance assumes material falling 90° off of conveyor

Formula/Durometer Color	Application	Material	Temperature
ETHER 80 (R80)	Used for fine particle abrasion, especially wet applications	Fine particles including sand, grain, 3/8" minus washed materials	-40°F to 225°F
ESTER 83 (G83)	Our standard, high abrasion-resistant all-purpose formulation	Dry sand and gravel materials, coal, ores	-40°F to 225°F
ETHER 90 (R90)	The lowest coefficient of friction formulation	1-1/2" washed/finished product. Wood chips, cement, limestone, grain, sugar, clay or other sticky material	-20°F to 225°F
ESTER 93 (B93)	Our high temperature formulation with high cut/tear properties	Extremely coarse aggregate, asphalt, recycled materials, glass, higher temp, sticky applications	-20°F to 250°F Up to 300°F intermittent



ARGONICS
ENGINEERED POLYURETHANE

520 9th Street • Gwinn, MI 49841
906.226.9747 f: 906.226.9779
www.argonics.com



The Argonics Nested Triangle logo, Kryptane® and Redi-Liner™ are trademarks or registered trademarks of Argonics, Inc.

LIB-AGG-RL-07-01 8/24



Load Zone Impact Bars



Our patented Load Zone impact bars are made of Kryptane® polyurethane and are engineered to absorb and disperse the forces of impact.

The Load Zone impact bar provides maximum protection for your belt surface and is produced exclusively by Argonics.

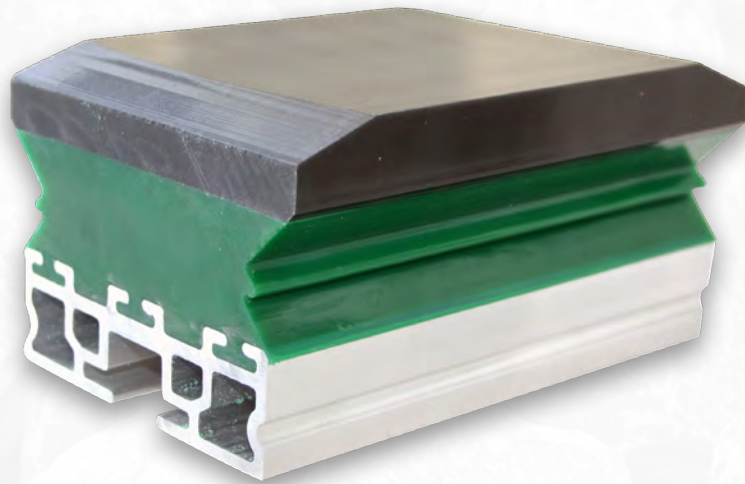

FEATURES:

- 3/4 inch thick Ultra High Molecular Weight (UHMW) wear surface
- Heavy-duty extruded aluminum insert for increased support and strength
- Replacement bar for most beds on the market
- No expensive T-bolt required
- Less rebound than rubber impact bars

BENEFITS:

- Reduces costs
- Decreases downtime
- Reduces maintenance time
- Reduces material spillage
- Minimizes belt damage
- Settles bulk product faster
- Longer time in between replacement

Sizes and Availability

NO T-BOLTS NECESSARY

All bars come standard with a heavy duty extruded aluminum insert, which provides rigidity and is designed to be installed using a standard 1/2 inch (13 mm) grade 8 bolt and washer, reducing cost by eliminating expensive T-bolts.

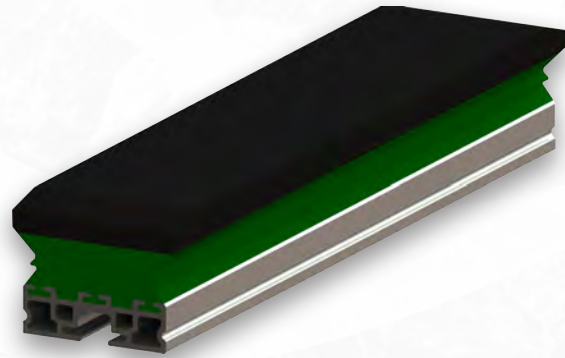
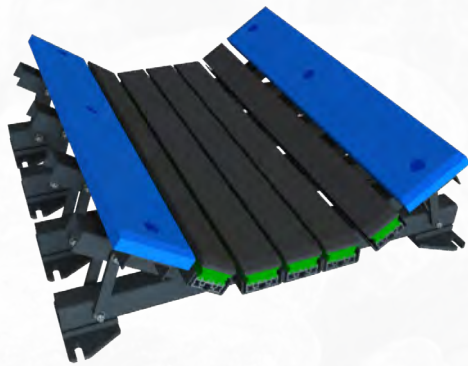

Part Number	Length (in)	Length (mm)
CP-IB-3418-A-G69	18	457
CP-IB-3424-A-G69	24	610
CP-IB-3448-A-G69	48	1220
CP-IB-3455-A-G69	55	1400
CP-IB-3460-A-G69	60	1525
CP-IB-3472-A-G69	72	1830



ARGONICS
ENGINEERED POLYURETHANE

520 9th Street • Gwinn, MI 49841
906.226.9747 f: 906.226.9779
www.argonics.com



The Argonics Nested Triangle logo and Kryptane® are trademarks or registered trademarks of Argonics, Inc.

Patent: 6,913,138 LIB-CP-IB-07-01 2/20

Aggregate Processing Parts



Screen decks provide many possibilities for wear, due to the abrasive materials being screened. Our polyurethane screen deck parts meet the demands of even the most abrasive material, whether it be sliding or impact abrasion, sticking, or corrosion.



AGGREGATE PRODUCTS:

- Screen deck shaft tube covers
- Crown bar channel covers
- Screen deck center hold downs
- Screen deck tension rails
- Spray shields
- Spray deflectors
- Nut protector cups and J-bolts
- Redi-Liners
- Wear plates
- Classifier shoes



Screen Deck Shaft Tube Cover

Our shaft tube cover wraps around the tube and bolts on for easy installation. It's preformed to fit the tube snugly and is thicker at the top to give you more wear material where it is needed. Available in lengths of 24" and 30", with nominal sizes of 6", 8", 12", and 17".

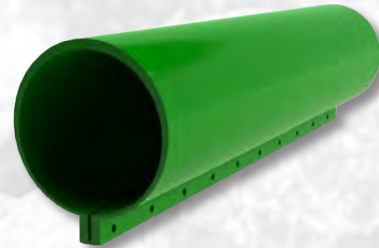

Crown Bar Channel Cover

This product lasts five times longer than a rubber channel cover. Available for 3/8" and 1/2" channel. Available in any length up to 25 feet.

Benefits include:

- Slightly tapered legs to prevent rolling off the bar under harsh conditions
- Reduces noise and vibration
- Extends the life of your screen
- Outstanding abrasion resistance

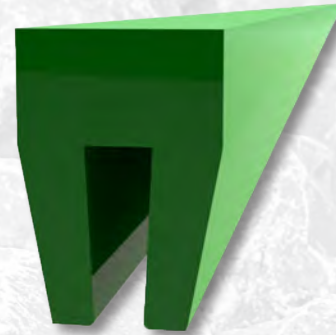

Screen Deck Center Hold Downs

Our polyurethane center hold downs are used on 7', 8', and 10' double-crown split screens. Available in 4- and 5-foot lengths.

The 1-3/8" thick top absorbs the shock of impact, and they're currently available in a standard 3" size. A hose can be run down the center to allow for a tighter fit against the hooks, if needed.



Screen Deck Tension Rail

Our screen deck tension rails are engineered for exceptional durability, featuring 1/4" steel rail construction paired with a 3/4" layer of abrasion-resistant polyurethane. They come in 48" and 60" lengths and are also offered in an all-steel option to meet your application needs.

Tension rails fit the following manufacturers:

- Cedarapids
- JCI
- Telsmith
- Pioneer
- Simplicity
- Allis-Chalmers
- El-Jay
- Lippman
- Hewitt-Robbins



Nut Protector Cups and J-Bolts

Argonics J-bolts and nut protector cups offer a reliable solution for securing screens to the crown bar. The polyurethane nut protectors shield the threads and nuts from damage caused by screening materials.

- J-bolts securely attach screen to the crown bar
- Nut cups protect the nut from damage and breakage
- J-bolts are 6" long and available in 1/2" and 5/8" dia.
- Nut protector donuts have a 1/2" or 5/8" opening
- Nut protectors can be purchased separately for use in a wide variety of applications
- J-bolts' rounded hook reduces breakage



Spray Shield

Designed to keep water on your deck where it belongs.

Simple, inexpensive, with an effective design, this product has a longer wear life than rubber boots. Available for 1 1/2", 2", and 3" pipe.

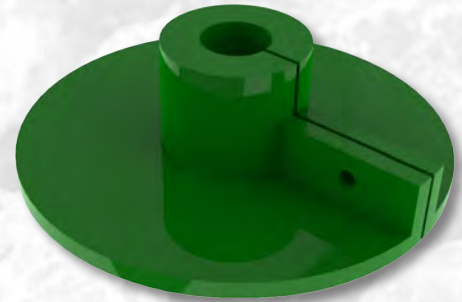

Spray Deflector

The longest lasting spray deflectors available, with easy installation and increased wash effectiveness. Available for 1 1/2" and 2" pipe.





Our Redi-Liner 12"x12" panels can be arranged into any wear pattern you need. Its unique, simple installation method allows you to replace only what's needed, instead of replacing the entire liner.

PERFECT FOR:

- Screen discharge liners
- Screen feed liners
- Conveyor transfer points
- Chutes with high wear
- Charge chutes

AVAILABILITY:

Choose from solid or ceramic-embedded polyurethane

- Ceramic-embedded available in 2" and 2½"
- Solid available in 1", 1½", 2", and 2½"

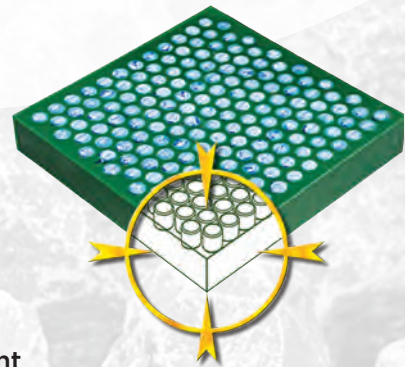

Impact Resistant

High alumina oxide ceramics

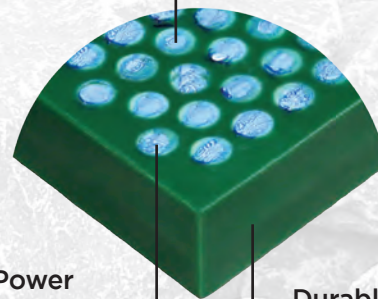

Holding Power

Mechanically and chemically bonded

Durable

Strong, wear-resistant polyurethane

Redi-Liner is easy to install, requires no maintenance, will outlast most any other wear product available, and provides protection for your toughest wear areas.

Wear Plates MODULAR LINING SYSTEM



Wear plates help eliminate material adhesion and dampen noise levels significantly. Our polyurethane wear plates have proven to be cost-effective over steel liners by as much as 5-to-1.

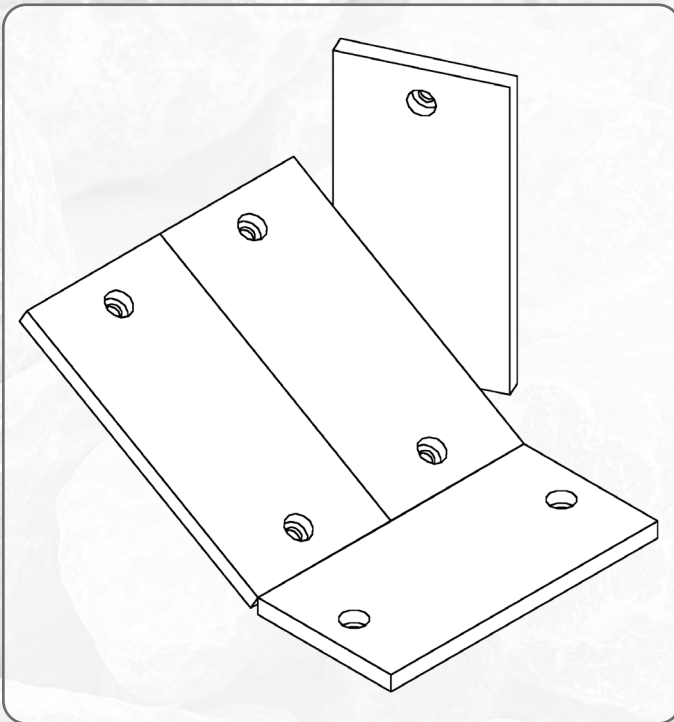

BENEFITS:

- High level of abrasion resistance
- Nonstick characteristics
- High-performance urethane extends plate life

Our wear plates are available in a variety of standard sizes, as well as weldable and boltable options. We can quickly produce custom sizes to suit your requirements.



We've replaced alloy shoes in sand and gravel plants around the world. Installation after installation, our classifier shoes outlast metal alloys and our competitors' best urethane shoes. We have classifier flight shoes available for most classification screws in the market with quick lead times. There is also a quick turnaround time on custom shoes.

REPLACEMENTS TO RETROFIT:

- Akins
- Blackstone
- Cindaco
- Denver
- Eagle
- Essco
- Greystone
- Kolberg
- Kolman
- Metz
- McLanahan
- Nermco
- Telsmith
- Torgenson
- Wemco





BENEFITS OF KRYPTANE® POLYURETHANE:

- Superior wear resistance
- Incredibly high split-tear resistance
- Not susceptible to thermal expansion
- Easy to handle and flexible
- Can be formulated to work in both wet and dry conditions



WHY ARGONICS?

We are one of the country's largest producers of hot cast polyurethane products. Many of these products are used in the concrete, aggregate, and mining industries. We can help with almost any wear or abrasion problems at your plant or facility.

Whether you're looking for custom liners, conveyor belt cleaners, or something else, we will tackle your wear problems from concept and design to solution and delivery.



ARGONICS
ENGINEERED POLYURETHANE

520 9th Street • Gwinn, MI 49841
906.226.9747 f: 906.226.9779
www.argonics.com



The Argonics Nested Triangle logo, and Kryptane® are trademarks or registered trademarks of Argonics, Inc.
LIB-AGG-AGG-07-01 9/21

Abrasion-resistant Polyurethane Liners



Argonics' Kryptane® polyurethane provides the most complete wear protection for your equipment. Kryptane has become the material of choice in many applications because of its outstanding physical properties, which produce a superior wear-resistant product, and the versatility of applications where it can be used.



BENEFITS:

- Incredibly high split-tear resistance
- Extreme wear resistance
- Reduced product adhesion due to low coefficient of friction
- High oil and grease resistance
- Not susceptible to thermal expansion
- Flexibility aids in proper fit
- Elastomeric properties reduce breakage of and damage to the conveyed product

TYPICAL APPLICATIONS:

- Bins
- Hoppers
- Turnheads
- Chutes
- Discharges



Abrasion-resistant Polyurethane Liners

Designed to extend the wear life and reduce maintenance requirements of your equipment

- Argonics' polyurethanes offer unparalleled abrasion and tear resistance. They have proven themselves time and time again over the past two decades and stand up to the harshest abrasive environments.
- Argonics' polyurethanes save your company money by reducing costly downtime in process equipment, reducing your overall production cost.
- Argonics' polyurethanes are lightweight, reduce noise, are easy to install and corrosion-resistant.
- Argonics' polyurethanes are not brittle like plastics, exhibit and elastomeric memory and are not subject to thermal expansion.
- Argonics' polyurethanes have better abrasion and tear resistance than rubber, have a higher load-bearing capability, are ozone and ultraviolet resistant, and can be manufactured in a wider range of durometers (hardness).

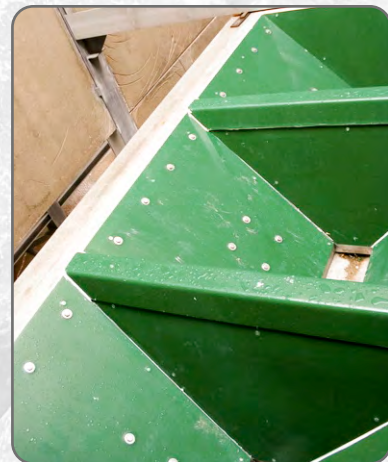

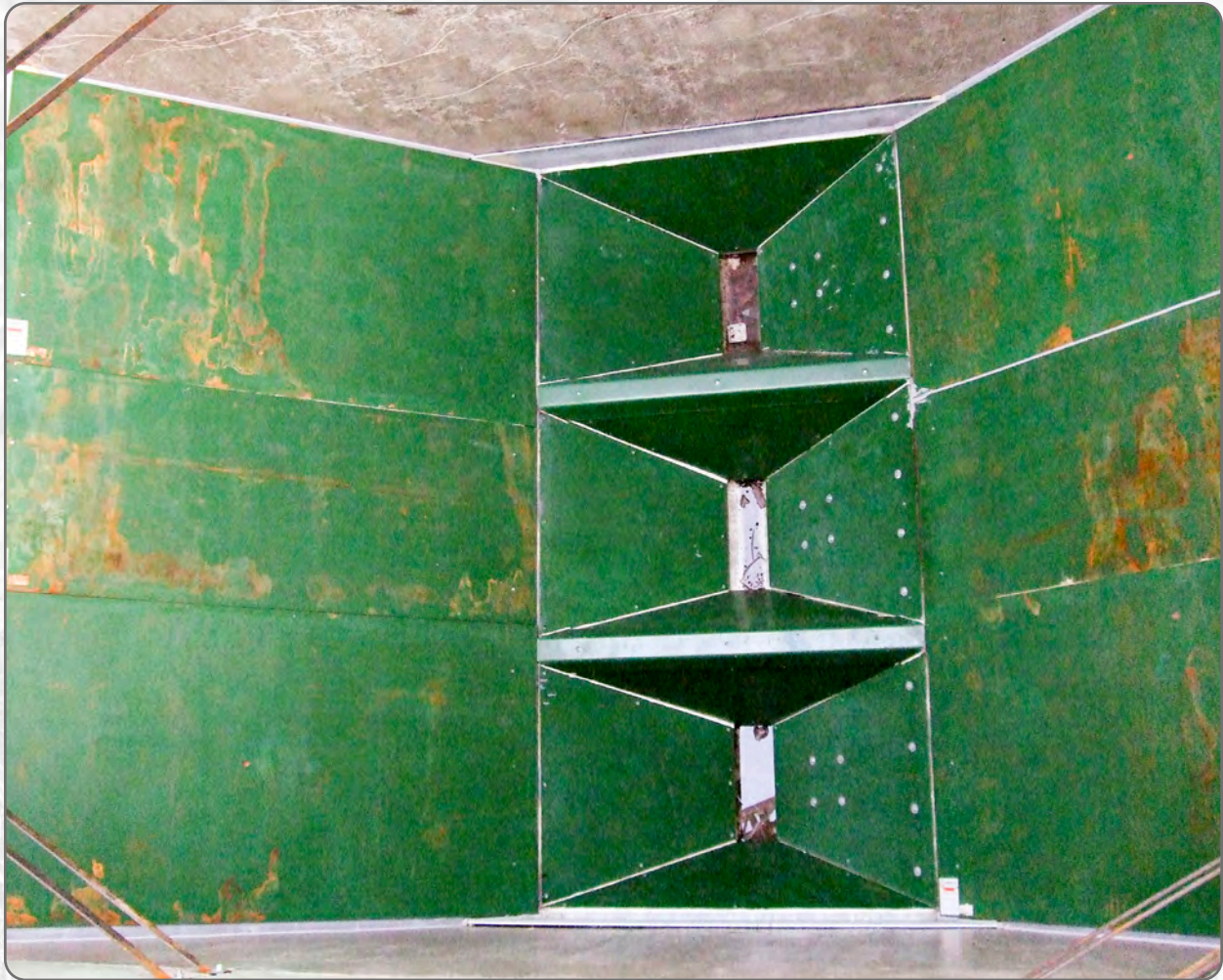

High quality products and value-added service

At Argonics, we pride ourselves on the superior performance of all of our urethane components designed and formulated for aggregate equipment.

We offer a cost-effective warranty on all of our materials. All Argonics parts are warranted against defects in material and workmanship for one year after the date of purchase.

Our goal is to provide top-quality products and great service that will meet or exceed your expectations. Our success is measured by our customers' satisfaction.

Comprehensive Analysis



Choosing the best solution for the application

Whether your wear issue is sliding abrasion, impact damage, sticking material or excessive corrosion, Argonics polyurethane liners are engineered to meet the particular demands of your specific application.

A comprehensive analysis addresses the problem at its source and guarantees maximum service life:

- Properties of the processed product
- Speed of the processed product
- Tonnage/loading of the application
- Product's drop height
- Impact angle of the product flow
- Ability to modify the application

The impact angle is an essential part of the analysis. The drawing to the right illustrates what happens when the impact angle is varied from 10 degrees to 90 degrees.

By correctly analyzing the proper application characteristics like the specific product type, the angle of impact and the wear issue to be addressed, Argonics polyurethane liners will provide a genuine improvement as a replacement for polyethylene, rubber, UHMW polyethylene and steel wear liners.

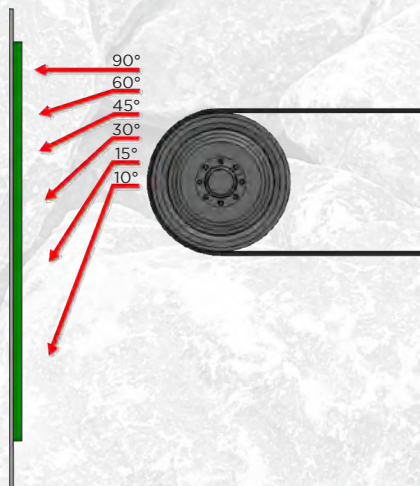

Ester Urethanes

KRYPTANE 83A GREEN

High abrasion resistance to harsh sliding, cutting and impact. Ideal for most sand and gravel materials, coal, ores. Impact angle of 30° to 60°.

KRYPTANE 83A FRAS

Specifically formulated for coal handling. Kryptane FRAS offers flame retardant anti-static properties that surpass the strictest standards. Impact angle of 30° to 60°.

KRYPTANE 93A BLACK

Strong abrasion resistance to sliding, grooving and impact. 1½" (38mm) washed/finished product. Impact angle of 60° to 90°.

KRYPTANE 63A YELLOW

Extremely elastic polyurethane with an exceptionally high resistance to impact of crushed rock up to 2" (50mm). Impact angle of 60° to 90°.



Ether Urethanes

KRYPTANE 80A RED

Resists sliding and/or impingement abrasion. Fine particles including sand, grain, 3/8" (9.5mm) minus washed materials. Impact angle of flat to 30°.

KRYPTANE 90A RED

Resists sliding and/or impact abrasion. Very low coefficient of friction. Fine particles up to 3/16" (5mm) in size, wet and dry. Impact angles of flat to 30°.

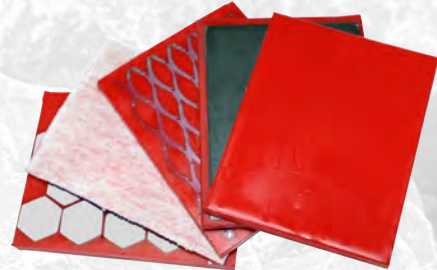

KRYPTANE ORANGE

MSHA-approved Front Line™ flame-retardant urethane can be any durometer or formulation. Impact angle of 30° to 60°.





Redi-Liner bolt-in 12"x12" panels can be arranged into any wear pattern that is needed. Their unique, simple installation method allows you to replace only what's needed instead of replacing the entire liner.

BENEFITS:

- Easy to install
- Requires no maintenance
- Will outlast most other wear product available
- Provides protection for tough wear spots in loading areas, hoppers and transfer points

Redi-Liner is available in both solid and ceramic-embedded polyurethane. Choose from a variety of durometers and formulas designed for a number of different applications.

Magnetic modular panels can be quickly and easily installed into any pattern to help reduce wear in critical areas of your operation.

BENEFITS:

- Rare earth magnets hold panels in place
- Panels can be placed together to address wear areas of any size
- Our 1/2" thick patches are perfect for covering holes in walls or chutes
- Easy to install with no added maintenance

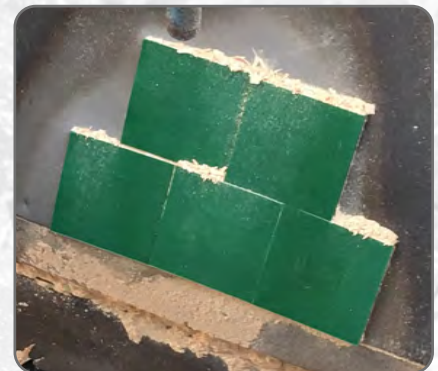

Panel sizes are available in 6"x6", 6"x12", 12"x12", and 12"x24". Thicknesses available are 1/2", 1", 1 1/2", and 2". Custom sizes available upon request.

CUSTOM LINERS OFFER A VERSATILE SOLUTION

Custom liners can be used anywhere our standard sheets don't fit, where weight and size are a concern, or where a long-term solution is needed. Our custom liners save you hours of labor usually spent cutting and fitting sheets in the field.

- Pieces are manufactured to fit precisely together
- Easy to replace one piece at a time
- No wasted material
- No extra labor cutting pieces from standard sheets
- Faster installation
- Extremely fast delivery

Ceramic Polyurethane Liners



KRYPTILE CERAMIC POLYURETHANE

Kryptile is the solution for aggressive applications. Kryptile ceramic liners combine the wear resistance of high alumina oxide ceramic with the impact resistance of Kryptane® polyurethane. Kryptile liners are all custom designed to the shape of your chute, bin or hopper, eliminating the need to cut or fit the liners in the field and ensuring a perfect fit every time.

KRYPTILE KT

Kryptile KT is the original ceramic hextile liner. The hextile formation is closely gapped to provide superior sliding abrasion resistance in high fines applications, wet or dry. Kryptile KT is generally not recommended for applications where there is impact; it is for slide abrasion only.

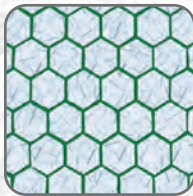

KRYPTILE KS

Kryptile KS is specifically designed for aggressive applications with high impact and large rock. Kryptile KS is generally recommended for applications with 10" (254mm) minus rock dropping from a maximum of 6 feet (1.83m).

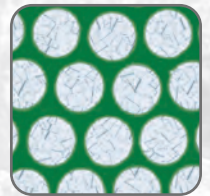

KRYPTILE KC

Kryptile KC works well in virtually all applications. Kryptile KC is available in liners at least 1 1/4" (32mm) thick. Kryptile KC is generally recommended for applications with 6" (152mm) minus rock dropping a maximum of 4 feet (1.22m).

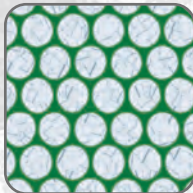

KRYPTILE KH

Kryptile KH is our ceramic cube liner. Kryptile KH is available in liners at least 2" (51mm) thick. Kryptile KH is generally recommended for applications with 15" (381mm) minus rock dropping from a maximum of 8-10+ feet (2.44-3.05+ meters).



Technical Specifications

OUR MOST COMMON POLYURETHANE FORMULATIONS

	Y63 Duro	R80 Duro	G83 Duro	R90 Duro	B93 Duro
Hardness durometer (shore A +/-5)	63	80	83	90	93
Tensile strength (PSI)	4865	4501	6600	4605	7500
100% modulus (PSI)	400	645	800	1216	1390
300% modulus (PSI)	708	1234	1264	2386	2250
500% modulus (PSI)	1947	2849	3413	4090	5500
Angle tear strength (die C) (lbf/in)	248	361	450	465	598
Trouser tear strength (lbf/in)	68	180	250	127	460
DIN abrasion loss (ml)	0.059	0.048	0.044	0.048	0.052
Cured density	1.21	1.05	1.21	1.05	1.21
Coefficient of friction	N/A	N/A	0.27	N/A	0.19



ARGONICS
ENGINEERED POLYURETHANE

520 9th Street • Gwinn, MI 49841

906.226.9747 f: 906.226.9779

www.argonics.com



The Argonics Nested Triangle logo, Kryptane®, and Redi-Liner™ are trademarks or registered trademarks of Argonics, Inc.
LIB-AGG-LIN-07-01 2/20

Concrete Products



Argonics' Kryptane® polyurethane provides the most complete wear protection for your plant. It has become the material of choice in many applications because of its superior wear-resistance, and the versatility of applications where it can be used.

TYPICAL APPLICATIONS:

- Central Mix Drums
- Bins/hoppers
- Chutes
- Turnheads
- Concrete truck parts
- Belt cleaners
- Skirting
- Custom liners

BENEFITS:

- Extreme wear resistance
- Reduced product sticking due to low coefficient of friction
- Reduced noise
- Easy cleanout



Evolution MIXER DRUM LINERS

The Evolution mixer drum liner features Argonics' unique Kryptane polyurethane formula, available in our standard ester formulation or our premium grade ether formula for enhance wear life and hydrolysis resistance.

Argonics guarantees the Evolution mixer drum liners with a five year or one million yard warranty.



PRODUCT BENEFITS:

- Improved weld plate design
- Large selection of liner sets available
- Over 30 years of proven performance
- Better than industry average lead times
- Standard and wrap-around tips available
- Written product warranty available upon request

Aggregate Batchers, Bins, Dump Cone, Turnheads & More



Liner Selection Guidelines

Most equipment at a concrete plant can be lined to protect it from abrasion.

TYPICAL THICKNESS SELECTIONS GUIDE:

1. Aggregate batcher	1/2" urethane
2. Aggregate bin/hopper	1/2" urethane
3. Central mix drum	1" urethane
4. Dump cone/directional hopper	3/4" urethane
5. Feed and discharge chutes	1" urethane
6. Turnhead	1" urethane

Maximum cost-effective performance can be reached through proper care and maintenance.

Kryptile

Our ceramic embedded liners combine the wear resistance of high alumina oxide ceramic with the impact resistance of our polyurethane.

Argonics brand Kryptile liners are engineered to address your specific wear issues and are custom designed to fit your equipment, eliminating the need to cut or fit the liners in the field and ensuring a perfect fit every time.



Sheets

Argonics provides a variety of standard sheet products for your needs. Standard sheets range in thickness from 1/4" to 1", and standard sizes are:

- 4' x 8'
- 4' x 10'
- 5' x 8'
- 5' x 10'



Backings

Our sheets are available in the following backings to suit your installation preference:

- Plain
- Weldable
- Expanded metal backed
- Solid metal backed

Weldable sheets are the most popular choice for the concrete industry and include the Snap-Tite plugs.

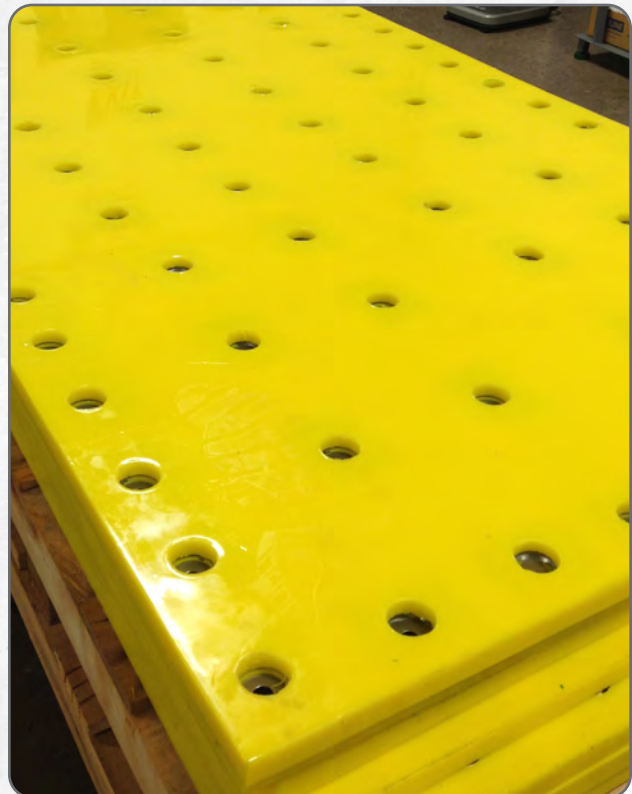

WELDABLE SHEETS

Charge Hopper Liners

- Weld-in design with Snap-Tite polyurethane plugs
- Easy wash downs and clean-up
- Wear-resistant polyurethane reduces downtime
- Reduces noise

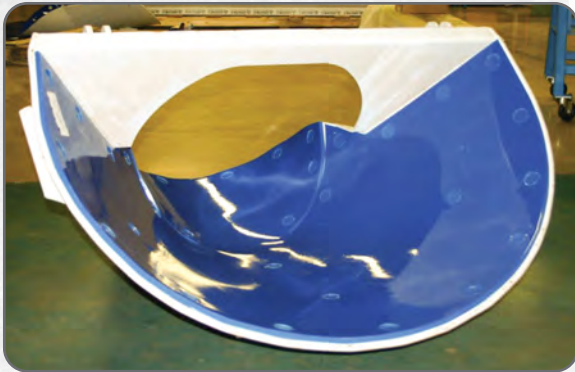

←
SNAP-TITE
PLUGS

Discharge Chute Bibs

- Superior abrasion resistance
- Long-lasting durability
- Won't curl or crack like rubber
- Concrete does not stick to bibs
- Custom colors to match your fleet
- Rear and front discharge liners available



Custom Liners

Argonics specializes in manufacturing custom liner sets with better than average delivery times. Custom liners are cast to the correct size, there is no waste and the seams are securely fastened to ensure a perfect fit. Installation labor times will be dramatically reduced. Custom liners from Argonics are often less expensive overall and can drastically decrease downtime associated with maintenance.

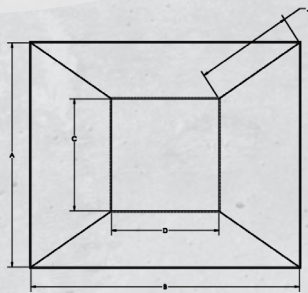
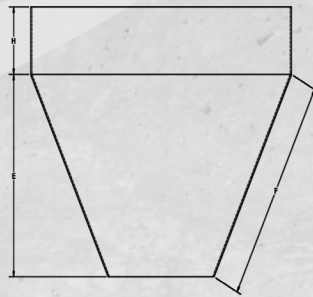
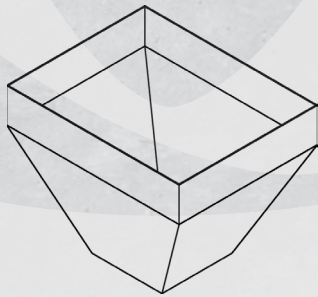

Note:

- Basic drawing can easily be used to quote. More detailed dimensions may be needed to manufacture.



Demand the Edge Proven Performance Products



KRYPTANE URETHANE PRODUCTS

Argonics formulates unique proprietary Kryptane urethane materials tailored to meet the demands of your wear application, whether it be sliding or impact abrasion, sticking or corrosion.

TYPICAL APPLICATIONS:

- Conveyor belt cleaners
- Distributor and launder liners
- Impact- and abrasion-resistant plates
- Down hold plugs and discharge sleeves
- Vibration pads, seals and gaskets
- Blasting curtains and screens
- Snowplow blades, shoes and deflectors
- Truck bed liners, wheel chocks and crossover pads
- Skirting systems
- Chute, bin and hopper liners
- Salt, sand and chemical spreaders
- Pipe, fitting and valve liners
- Chain and cable guides

WE SERVICE ALL INDUSTRIAL APPLICATIONS:

- Agriculture
- Materials Handling
- Power
- Aggregate
- Concrete
- Utility
- Mining
- Pulp and Paper
- Manufacturing

AWARDS:

- Honored as one of Michigan's 50 Companies to Watch
- Award for Entrepreneurial Excellence, Operation Action U.P.
- Award of Excellence, Operation Action U.P.
- Named one of Michigan's Best Small Businesses

Argonics is one of the country's largest producers of wear-resistant polyurethane products, manufactured at its state-of-the-art production facility.

Whether you're producing concrete, manufacturing aggregate products, processing grain or mining precious metal, Argonics provides high-performance, cost-effective urethane solutions for the most demanding applications.

Argonics formulates Kryptane polyurethane products to meet your industrial applications.

Argonics' high performance polyurethane materials have proven effective, with easy installation, reduced maintenance costs and reduced downtimes. Argonics products save customers thousands of dollars in lost production and man-hours. Our success is measured by our customers' satisfaction.



ARGONICS
ENGINEERED POLYURETHANE

The Argonics Nested Triangle logo, Micro Eraser™, Eraser PQ™, Eraser™, S3Max™, Super Eraser™, Eraser HD™, Super Eraser HD™, XTC™, Eraser DS™, Super-G™, V-Max X-Plow™, E-Max V-Plow™, V-Max V-Plow™, Perma-Torque™, Safe Torque™, Web-Torque™, Fold-n-Seal™, KS01™, Snap-Loc™, Wedge-Loc™, Load Zone™, Kryptile™, Redi-Liner™, Evolution™, Xtreme™, Blue Ox™, and Raptor™ are trademarks, and Kryptane is a registered trademark of Argonics, Inc. Gwinn, MI. USA

Patents:	6,056,112	7,441,647	5,979,638	7,284,658
	6,318,545	6,913,138	6,547,062	7,484,617

LIB-AR-CA-07-02 4/2023

520 9th Street • Gwinn, MI 49841

906.226.9747

fax: 906.226.9779

www.argonics.com

 facebook.com/argonics

 youtube.com/ArgonicsInc

 linkedin.com/company/argonics-inc.